

Chiavi e cilindri
Keys and cylinders

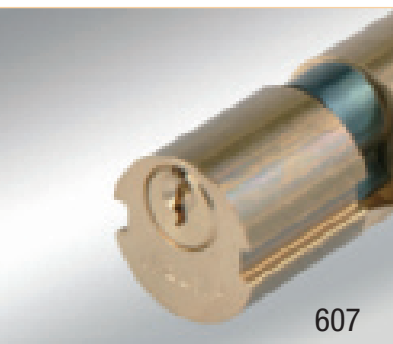

607



700



770





702

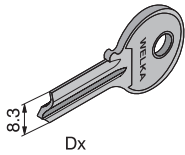

Chiave grezza in ottone nichelato. Per cilindri a 5 spine.

Blank key nickel plated.



ARTICOLO Article	FINITURA Finish	Mano Hand			Quantità min. da ordinare	
500.05.00.1	Ottone nichelato - <i>Nickel brass</i>	DX	5	100	100	
500.05.00.8	Chiave supplementare - <i>Supplementary key (ABK)</i> Ottone nichelato - <i>Nickel brass</i>		5			
500.05.00.9	Chiave al campione - <i>Key to sample (SBK)</i> Ottone nichelato - <i>Nickel brass</i>		5			

PER CILINDRI



Art.
600-604-700-721
603.00
609.00 - 609.01 - 609.02
609.03 - 609.04

For cylinders

Chiave grezza in ottone nichelato. Per cilindri a 4 spine.

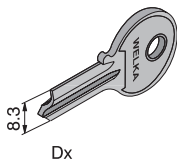
Blank key nickel plated.



ARTICOLO Article	FINITURA Finish	Mano Hand			Quantità min. da ordinare	
501.04.00.1	Ottone nichelato - <i>Nickel brass</i>	DX	4	100	100	
501.04.00.8	Chiave supplementare - <i>Supplementary key (ABK)</i> Ottone nichelato - <i>Nickel brass</i>		4			
501.04.00.9	Chiave al campione - <i>Key to sample (SBK)</i> Ottone nichelato - <i>Nickel brass</i>		4			

PER CILINDRI



Art.
600-601-605-700-721

For cylinders

Chiave grezza in ottone nichelato, profilo ridotto.
Per cilindri a 4 spine.

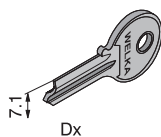
Blank key reduced nickel plated.



ARTICOLO Article	FINITURA Finish	Mano Hand			Quantità min. da ordinare	
502.04.00.1	Ottone nichelato - <i>Nickel brass</i>	DX	4	100	100	
502.04.00.8	Chiave supplementare - <i>Supplementary key (ABK)</i> Ottone nichelato - <i>Nickel brass</i>		4			
502.04.00.9	Chiave al campione - <i>Key to sample (SBK)</i> Ottone nichelato - <i>Nickel brass</i>		4			

PER CILINDRI

Art.
607-608-702-722

For cylinders

Chiave grezza in ottone nichelato.

Blank key nickel plated.

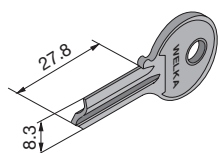

ARTICOLO Article	FINITURA Finish	Mano Hand			Quantità min. da ordinare
503.05.00.2	Ottone nichelato - <i>Nickel brass</i>	SX	5	100	100
503.05.00.8	Chiave supplementare - <i>Supplementary key (ABK)</i> Ottone nichelato - <i>Nickel brass</i>	DX	5		
503.05.00.9	Chiave al campione - <i>Key to sample (SBK)</i> Ottone nichelato - <i>Nickel brass</i>	DX	5		

PER SERRATURE

Art.
012

For locks

PER CILINDRI

Art.
603.02.00.0
604.02.00.0

For cylinders

Chiave a spillo in acciaio nichelato.

Cross key nickel steel.

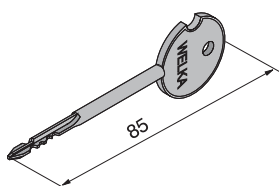

ARTICOLO Article	FINITURA Finish			Quantità min. da ordinare
505.07.00.0	Ottone nichelato - <i>Nickel brass</i>	6	25	25
505.07.00.8	Chiave supplementare - <i>Supplementary key (ABK)</i> Ottone nichelato - <i>Nickel brass</i>			
505.07.00.9	Chiave al campione - <i>Key to sample (SBK)</i> Ottone nichelato - <i>Nickel brass</i>			

PER CILINDRI

Art.
770

For cylinders

Chiave grezza in ottone nichelato.

Blank key nickel plated.

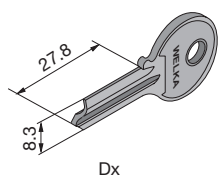

ARTICOLO Article	FINITURA Finish	Mano Hand			Quantità min. da ordinare
507.05.00.2	Ottone nichelato - <i>Nickel brass</i>	SX	6	100	100
507.05.00.8	Chiave supplementare - <i>Supplementary key (ABK)</i> Ottone nichelato - <i>Nickel brass</i>				
507.05.00.9	Chiave al campione - <i>Key to sample (SBK)</i> Ottone nichelato - <i>Nickel brass</i>				

PER SERRATURE

Art.
030-031-076-077

For locks

PER CILINDRI

Art.
609.05.00.0

For cylinders

Cilindro sagomato in ottone, leva Welka centrale.

Brass profile cylinder, central Welka lever.

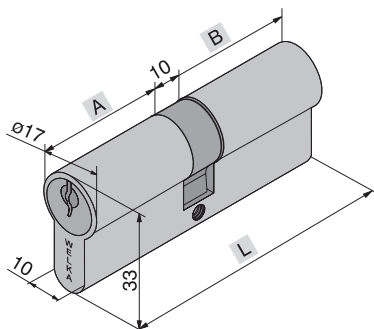

Distanza fissa tra **A** e **B**: 10 mm
Fixed distance between **A** and **B**: 10 mm

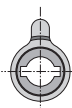

Leva Welka

ARTICOLO Article	FINITURA Finish	A	B	L			Quantità min. da ordinare
600.22.22.0	Ottone - Brass	22	22	54	4	1	1
600.22.28.0		22	28	60	4	1	1
600.22.34.0		22	34	66	4	1	1
600.22.38.0		22	38	70	4	1	1
600.26.26.0		26	26	62	5	1	1

ARTICOLO Article	IMPIANTI SPECIALI - DESCRIZIONE Special execution - description	Sigla Abbreviation
995.00.00.0	Cifratura a chiave uguale a ns. scelta - Key alike	KA
996.00.00.0	Cifratura a chiave uguale al campione - Key alike to the sample	KAS

IN DOTAZIONE **Art.** **Included**
N° 3 Chiavi 500-501 N° 3 Keys

Cilindro sagomato in ottone nichelato, leva Welka centrale.

Nickel plated Brass profile cylinder, central Welka lever.

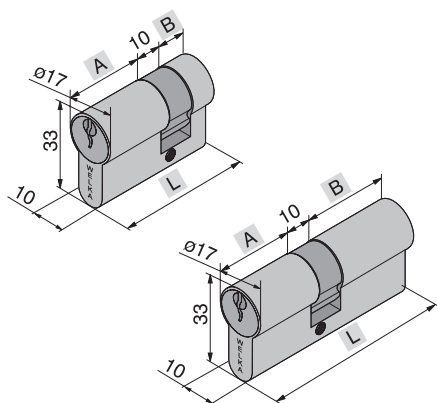

Distanza fissa tra **A** e **B**: 10 mm
Fixed distance between **A** and **B**: 10 mm

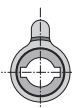

Leva Welka

ARTICOLO Article	FINITURA Finish	A	B	L			Quantità min. da ordinare
601.22.05.1	Nichelato - Nickel	22	5	37	4	1	1
601.22.22.1		22	22	54	4	1	1

PER SERRATURE **Art.** **For locks**
085-087-088 - E 19 mm



IN DOTAZIONE **Art.** **Included**
N° 3 Chiavi 501 N° 3 Keys

ARTICOLO Article	IMPIANTI SPECIALI - DESCRIZIONE Special execution - description	Sigla Abbreviation
995.00.00.0	Cifratura a chiave uguale a ns. scelta - Key alike	KA
996.00.00.0	Cifratura a chiave uguale al campione - Key alike to the sample	KAS

Cilindro fisso Ø 25 mm.

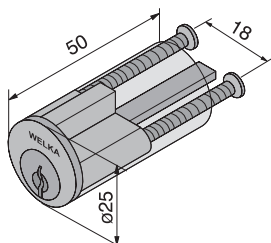
Fixed cylinder Ø 25 mm.





ARTICOLO Article	FINITURA Finish			Quantità min. da ordinare
603.00.00.1	Nichelato - Nickel mm 50	5	10	10
603.35.00.1	Nichelato - Nickel mm 35	5	10	10
603.60.00.1	Nichelato - Nickel mm 60	5	10	10

PER SERRATURE Art. 011 **For locks**

IN DOTAZIONE Art. 500 **Included**
N° 3 Chiavi N° 3 Keys

ARTICOLO Article	IMPIANTI SPECIALI - DESCRIZIONE Special execution - description	Sigla Abbreviation
995.00.00.0	Cifratura a chiave uguale a ns. scelta - Key alike	KA
996.00.00.0	Cifratura a chiave uguale al campione - Key alike to the sample	KAS

ARTICOLO Article	FINITURA Finish			Quantità min. da ordinare
603.02.00.0	Ottone 50 mm - Brass mm 50	5	10	10
603.03.00.0	Ottone 60 mm - Brass mm 60	5	10	10

PER SERRATURE Art. 012 **For locks**

IN DOTAZIONE Art. 503 **Included**
N° 3 Chiavi N° 3 Keys

Cilindro staccato Ø 25 mm.

Loose cylinder Ø 25 mm.

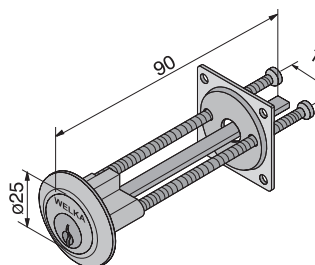

ARTICOLO Article	FINITURA Finish			Quantità min. da ordinare
604.00.00.1	Nichelato - Nickel	5	10	10

PER SERRATURE Art. 011 **For locks**

IN DOTAZIONE Art. 500 **Included**
N° 3 Chiavi N° 3 Keys

ARTICOLO Article	IMPIANTI SPECIALI - DESCRIZIONE Special execution - description	Sigla Abbreviation
995.00.00.0	Cifratura a chiave uguale a ns. scelta - Key alike	KA
996.00.00.0	Cifratura a chiave uguale al campione - Key alike to the sample	KAS

ARTICOLO Article	FINITURA Finish			Quantità min. da ordinare
604.02.00.0	Ottone - Brass	5	10	10

PER SERRATURE Art. 012 **For locks**

IN DOTAZIONE Art. 503 **Included**
N° 3 Chiavi N° 3 Keys

Coppia cilindri nichelati Ø 25 mm.

Couple of nickel cylinders Ø 25 mm.

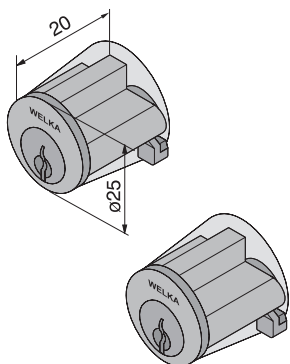

ARTICOLO Article	FINITURA Finish			Quantità min. da ordinare
605.00.00.1	Nichelato - Nickel	4	10	10



PER SERRATURE Art. 050-051-053-060 062-065-066 **For locks**

IN DOTAZIONE N° 3 Chiavi Art. 501 **Included** N° 3 Keys

Mezzo cilindro tondo in ottone Ø 22 mm, leva Welka centrale.

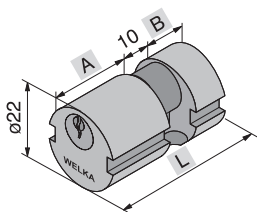
Half round brass cylinder Ø 22 mm, central Welka lever.



ARTICOLO Article	FINITURA Finish	A	B	L			Quantità min. da ordinare
607.22.05.0	Ottone - Brass	22	5	37	4	1	1

PER SERRATURE Art. 067-123 **For locks**

IN DOTAZIONE N° 3 Chiavi Art. 502 **Included** N° 3 Keys

Distanza fissa tra A e B: 10 mm
Fixed distance between A and B: 10 mm





Leva Welka

ARTICOLO Article	IMPIANTI SPECIALI - DESCRIZIONE Special execution - description	Sigla Abbreviation
995.00.00.0	Cifratura a chiave uguale a ns. scelta - Key alike	KA
996.00.00.0	Cifratura a chiave uguale al campione - Key alike to the sample	KAS

Cilindro tondo in ottone Ø 22 mm, leva Welka centrale.

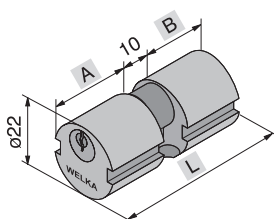
Round brass cylinder Ø 22 mm, central Welka lever.



ARTICOLO Article	FINITURA Finish	A	B	L			Quantità min. da ordinare
607.22.22.0	Ottone - Brass	22	22	54	4	1	1
607.22.28.0		22	28	60	4	1	1
607.22.38.0		22	38	70	4	1	1
607.22.48.0		22	48	80	4	1	1

PER SERRATURE Art. 067-123 **For locks**

IN DOTAZIONE N° 3 Chiavi Art. 502 **Included** N° 3 Keys

Distanza fissa tra A e B: 10 mm
Fixed distance between A and B: 10 mm

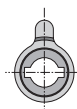



Leva Welka

ARTICOLO Article	IMPIANTI SPECIALI - DESCRIZIONE Special execution - description	Sigla Abbreviation
995.00.00.0	Cifratura a chiave uguale a ns. scelta - Key alike	KA
996.00.00.0	Cifratura a chiave uguale al campione - Key alike to the sample	KAS

Mezzo cilindro tondo in ottone Ø 25 mm, leva Welka centrale.

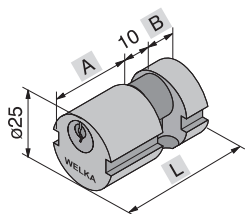
Half round brass cylinder Ø 25 mm, central Welka lever.



ARTICOLO Article	FINITURA Finish	A	B	L			Quantità min. da ordinare
608.22.05.0	Ottone - Brass	22	5	37	4	1	1

PER SERRATURE Art. 054-055-071-073-075 **For locks**

IN DOTAZIONE N° 3 Chiavi Art. 502 **Included** N° 3 Keys

Distanza fissa tra **A** e **B**: 10 mm
Fixed distance between **A** and **B**: 10 mm

ARTICOLO Article	IMPIANTI SPECIALI - DESCRIZIONE Special execution - description	Sigla Abbreviation
995.00.00.0	Cifratura a chiave uguale a ns. scelta - Key alike	KA
996.00.00.0	Cifratura a chiave uguale al campione - Key alike to the sample	KAS

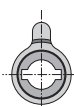



Leva Welka

Cilindro tondo in ottone Ø 25 mm, leva Welka centrale.

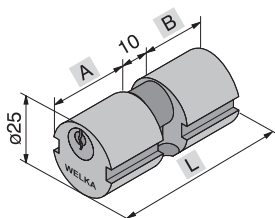
Round brass cylinder Ø 25 mm, central Welka lever.



ARTICOLO Article	FINITURA Finish	A	B	L			Quantità min. da ordinare
608.22.22.0	Ottone - Brass	22	22	54	4	1	1
608.22.28.0		22	28	60	4	1	1
608.22.38.0		22	38	70	4	1	1
608.22.48.0		22	48	80	4	1	1

PER SERRATURE Art. 054-055-071-073-075 **For locks**

IN DOTAZIONE N° 3 Chiavi Art. 502 **Included** N° 3 Keys

Distanza fissa tra **A** e **B**: 10 mm
Fixed distance between **A** and **B**: 10 mm

ARTICOLO Article	IMPIANTI SPECIALI - DESCRIZIONE Special execution - description	Sigla Abbreviation
995.00.00.0	Cifratura a chiave uguale a ns. scelta - Key alike	KA
996.00.00.0	Cifratura a chiave uguale al campione - Key alike to the sample	KAS

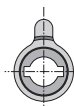

Leva Welka

Coppia cilindri fissi nichelati Ø 25 mm.

Couple of nickel fixed cylinders Ø 25 mm.

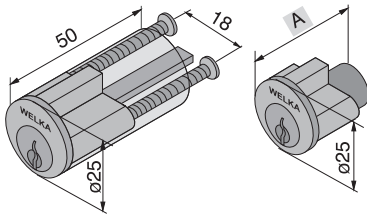

ARTICOLO Article	FINITURA Finish	A			Quantità min. da ordinare
609.01.00.1	Nichelato - Nickel	27	5	10	10
609.03.00.1		31	5	10	10

PER SERRATURE	Art.	For locks
Misura A: 27	331	
Misura A: 37	333	
IN DOTAZIONE	Art.	Included
N° 3 Chiavi	500	N° 3 Keys

ARTICOLO Article	IMPIANTI SPECIALI - DESCRIZIONE Special execution - description	Sigla Abbreviation
995.00.00.0	Cifratura a chiave uguale a ns. scelta - Key alike	KA
996.00.00.0	Cifratura a chiave uguale al campione - Key alike to the sample	KAS

Coppia cilindri staccati nichelati Ø 25 mm.

Couple of nickel loose cylinders Ø 25 mm.

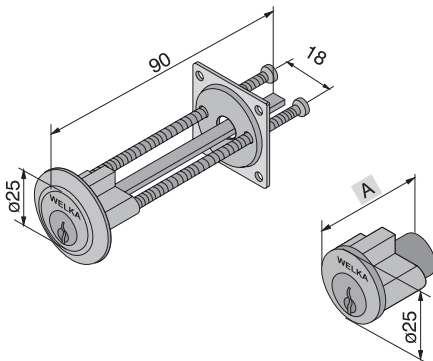

ARTICOLO Article	FINITURA Finish	A			Quantità min. da ordinare
609.02.00.1	Nichelato - Nickel	27	5	10	10
609.04.00.1		31	5	10	10

PER SERRATURE	Art.	For locks
Misura A: 27	331	
Misura A: 37	333	
IN DOTAZIONE	Art.	Included
N° 3 Chiavi	500	N° 3 Keys

ARTICOLO Article	IMPIANTI SPECIALI - DESCRIZIONE Special execution - description	Sigla Abbreviation
995.00.00.0	Cifratura a chiave uguale a ns. scelta - Key alike	KA
996.00.00.0	Cifratura a chiave uguale al campione - Key alike to the sample	KAS

Mezzo cilindro sagomato in ottone, leva DIN sporgente 30°.

Half Brass profile cylinder, DIN lever 30°.

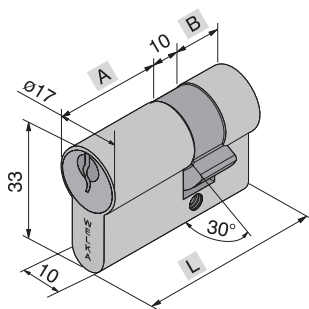

ARTICOLO Article	FINITURA Finish	A	B	L			Quantità min. da ordinare
700.22.05.0	Ottone - Brass	22	5	37	4	1	1
700.26.05.0		26	5	41	5	1	1
700.28.05.0		28	5	43	5	1	1
700.38.05.0		38	5	53	5	1	1

IN DOTAZIONE
N° 3 Chiavi

Art.
500-501

Included
N° 3 Keys

Distanza fissa tra **A** e **B**: 10 mm
Fixed distance between **A** and **B**: 10 mm

ARTICOLO Article	FINITURE DISPONIBILI Available Finishes
700.—.05.1	Ottone nichelato - Nickel brass

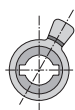

Leva DIN 30°

ARTICOLO Article	IMPIANTI SPECIALI - DESCRIZIONE Special execution - description	Sigla Abbreviation
995.00.00.0	Cifratura a chiave uguale a ns. scelta - Key alike	KA
996.00.00.0	Cifratura a chiave uguale al campione - Key alike to the sample	KAS

Cilindro sagomato in ottone, leva DIN 30°.

Brass profile cylinder, DIN lever 30°.

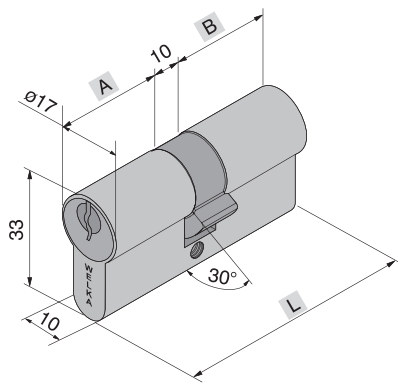

Distanza fissa tra **A** e **B**: 10 mm
Fixed distance between **A** and **B**: 10 mm

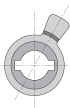

Leva DIN 30°

ARTICOLO Article	FINITURA Finish	A	B	L			Quantità min. da ordinare
700.22.22.0	Ottone - Brass	22	22	54	4	1	1
700.22.26.0		22	26	58	4	1	1
700.22.28.0		22	28	60	4	1	1
700.22.30.0		22	30	62	4	1	1
700.22.34.0		22	34	66	4	1	1
700.22.38.0		22	38	70	4	1	1
700.22.42.0		22	42	74	4	1	1
700.22.48.0		22	48	80	4	1	1
700.25.30.0		25	30	65	5	1	1
700.25.35.0		25	35	70	5	1	1
700.25.40.0		25	40	75	5	1	1
700.26.26.0		26	26	62	5	1	1
700.28.28.0		28	28	66	5	1	1
700.28.34.0		28	34	72	5	1	1
700.28.38.0		28	38	76	5	1	1
700.28.42.0		28	42	80	5	1	1
700.28.48.0		28	48	86	5	1	1
700.30.30.0		30	30	70	5	1	1
700.34.34.0		34	34	82	5	1	1
700.34.38.0		34	38	82	5	1	1
700.34.42.0		34	42	86	5	1	1
700.34.48.0		34	48	92	5	1	1
700.38.38.0		38	38	86	5	1	1
700.38.42.0		38	42	90	5	1	1
700.38.48.0		38	48	96	5	1	1
700.42.42.0		42	42	94	5	1	1
700.42.48.0		42	48	100	5	1	1
700.48.48.0		48	48	106	5	1	1

IN DOTAZIONE
N° 3 Chiavi

Art.
500-501

Included
N° 3 Keys



ARTICOLO Article	FINITURE DISPONIBILI Available Finishes	Quantità min. da ordinare
700.---.---.1	Ottone nichelato - Nickel brass	1
700.---.---.3	Ottone cromato lucido - Polish chrome brass	500
700.---.---.5	Ottone cromato Satinato - Satin chrome brass	500
700.---.---.6	Ottone nichel perla - Pearl nickel brass	50
700.---.---.10	Bronzo antico - Antique bronze	500

ARTICOLO Article	IMPIANTI SPECIALI - DESCRIZIONE Special execution - description	Sigla Abbreviation
995.00.00.0	Cifraturo a chiave uguale a ns. scelta - Key alike	KA
996.00.00.0	Cifraturo a chiave uguale al campione - Key alike to the sample	KAS

Mezzo cilindro ovale in ottone mm 13x28, leva Welka centrale.

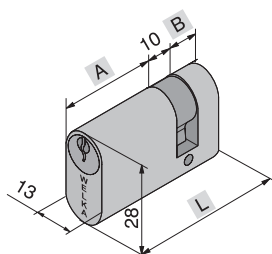
Half oval brass cylinder mm 13x28, central Welka lever.



ARTICOLO Article	FINITURA Finish	A	B	L			Quantità min. da ordinare
702.22.05.0	Ottone - Brass	22	5	37	4	1	1
702.28.05.0		28	5	43	4	1	1
702.38.05.0		38	5	53	4	1	1

IN DOTAZIONE
N° 3 Chiavi

Art.
502

Included
N° 3 Keys

Distanza fissa tra **A** e **B**: 10 mm
Fixed distance between **A** and **B**: 10 mm

ARTICOLO Article	FINITURE DISPONIBILI Available Finishes
702.—.05.1	Ottone Nichelato - Nickel Brass

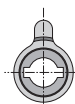

Leva Welka



ARTICOLO Article	IMPIANTI SPECIALI - DESCRIZIONE Special execution - description	Sigla Abbreviation
995.00.00.0	Cifratura a chiave uguale a ns. scelta - Key alike	KA
996.00.00.0	Cifratura a chiave uguale al campione - Key alike to the sample	KAS

Cilindro ovale in ottone mm 13x28, leva Welka centrale.

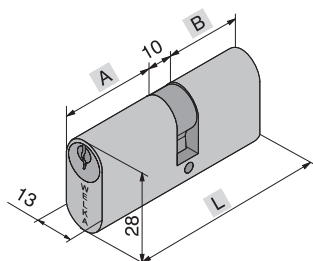
Oval brass cylinder mm 13x28, central Welka lever.



Distanza fissa tra **A** e **B**: 10 mm
Fixed distance between **A** and **B**: 10 mm

ARTICOLO Article	FINITURA Finish	A	B	L			Quantità min. da ordinare
702.22.22.0	Ottone - Brass	22	22	54	4	1	1
702.22.28.0		22	28	60	4	1	1
702.22.34.0		22	34	66	4	1	1
702.22.38.0		22	38	70	4	1	1
702.22.42.0		22	42	74	4	1	1
702.22.48.0		22	48	80	4	1	1
702.25.25.0		25	25	60	4	1	1
702.28.28.0		28	28	66	4	1	1
702.28.38.0		28	38	76	4	1	1
702.28.48.0		28	48	86	4	1	1

IN DOTAZIONE
N° 3 Chiavi

Art.
502

Included
N° 3 Keys

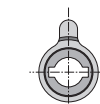

Leva Welka

ARTICOLO Article	FINITURE DISPONIBILI Available Finishes
702.—.—.1	Ottone nichelato - Nickel brass

ARTICOLO Article	IMPIANTI SPECIALI - DESCRIZIONE Special execution - description	Sigla Abbreviation
995.00.00.0	Cifratura a chiave uguale a ns. scelta - Key alike	KA
996.00.00.0	Cifratura a chiave uguale al campione - Key alike to the sample	KAS

Mezzo cilindro sagomato in ottone, leva Din 30° predisposto per il pomolo.

Half brass profile cylinder, Din lever 30° pre-arranged for knob.

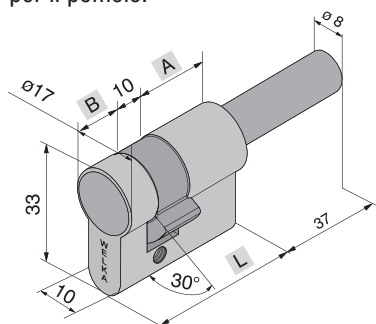

Distanza fissa tra A e B: 10 mm
Fixed distance between A and B: 10 mm

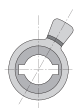

Leva DIN 30°

ARTICOLO Article	FINITURA Finish	A	B	L			Quantità min. da ordinare
721.22.05.0	Ottone - Brass	22	5	37	1	1	1
721.22.05.1	Ottone nichelato - Nickel brass	22	5	37	1	1	1

IN DOTAZIONE
N° 1 Borchia

Art.
800.04.--.0

Included
N° 1 Roses

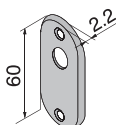

A RICHIESTA
Pomolo tondo zama
Pomolo triangolare ottone
Pomolo piatto alluminio

Art.
750
751
752

Not included
Zamak round knobs
Brass triangular knob
Aluminium flat knob

Cilindro sagomato in ottone, leva Din 30° predisposto per il pomolo.

Brass profile cylinder, Din lever 30° pre-arranged for knob.

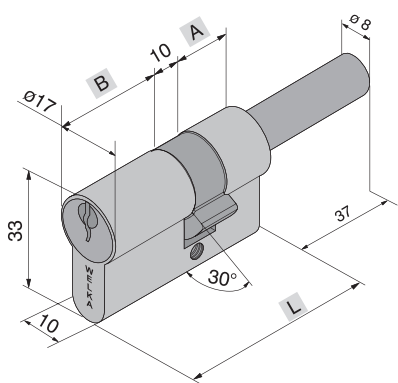

Distanza fissa tra A e B: 10 mm
Fixed distance between A and B: 10 mm

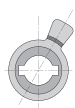

Leva DIN 30°

ARTICOLO Article	FINITURA Finish	A	B	L			Quantità min. da ordinare
721.22.22.0	Ottone - Brass	22	22	54	4	1	1
721.22.28.0		22	28	60	5	1	1
721.22.34.0		22	34	66	5	1	1
721.22.38.0		22	38	70	5	1	1
721.22.42.0		22	42	74	5	1	1
721.22.48.0		22	48	80	5	1	1

IN DOTAZIONE
N° 3 Chiavi
N° 1 Borchia

Art.
500-501
800.04.--.0

Included
N° 3 Keys
N° 1 Roses

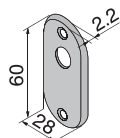

A RICHIESTA
Pomolo tondo zama
Pomolo triangolare ottone
Pomolo piatto alluminio

Art.
750
751
752

Not included
Zamak round knobs
Brass triangular knob
Aluminium flat knob

ARTICOLO Article	FINITURE DISPONIBILI Available Finishes	Quantità min. da ordinare
721.--.--.1	Ottone nichelato - Nickel brass	1
721.--.--.3	Ottone cromato lucido - Polish chrome brass	500
721.--.--.5	Ottone cromato Satinato - Satin chrome brass	500
721.--.--.6	Ottone nichel perla - Pearl nickel brass	50
721.--.--.10	Bronzo antico - Antique bronze	500



ARTICOLO Article	IMPIANTI SPECIALI - DESCRIZIONE Special execution - description	Sigla Abbreviation
995.00.00.0	Cifratura a chiave uguale a ns. scelta - Key alike	KA
996.00.00.0	Cifratura a chiave uguale al campione - Key alike to the sample	KAS

Cilindro ovale in ottone mm 13x28, leva Welka centrale con pomolo in zama ottonato.

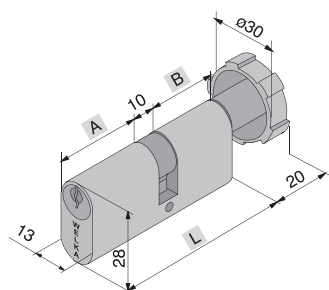

Oval brass cylinder mm 13x28, central Welka lever with brassed zamak knob.

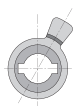

Distanza fissa tra **A** e **B**: 10 mm
Fixed distance between **A** and **B**: 10 mm



Leva DIN 30°

ARTICOLO Article	FINITURA Finish	A	B	L			Quantità min. da ordinare
722.22.22.0	Ottone - Brass	22	22	54	4	1	1
722.22.28.0		22	28	60	4	1	1

IN DOTAZIONE
N° 3 Chiavi

Art.
502



Included
N° 3 Keys

ARTICOLO Article	IMPIANTI SPECIALI - DESCRIZIONE Special execution - description	Sigla Abbreviation
995.00.00.0	Cifatura a chiave uguale a ns. scelta - Key alike	KA
996.00.00.0	Cifatura a chiave uguale al campione - Key alike to the sample	KAS

Cilindro sagomato in ottone, leva DIN 30°, con pomolo piatto.

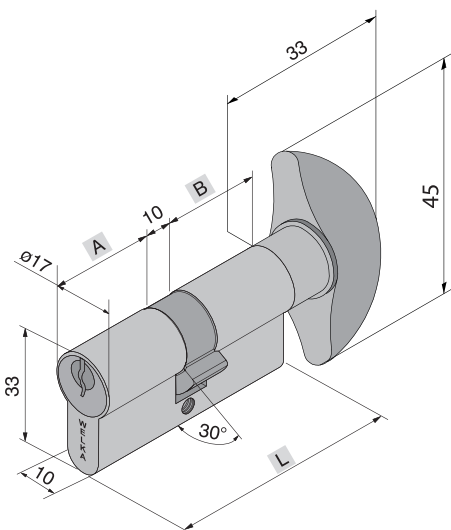
Brass profile cylinder, Din lever 30° with flat knob.



ARTICOLO Article	FINITURA Finish	A	B	L			Quantità min. da ordinare
731.22.22.0	Ottone - Brass	22	22	54	4	1	1
731.22.28.0		22	28	60	4	1	1
731.26.26.0		26	26	62	5	1	1
731.28.22.0		28	22	60	5	1	1
731.28.28.0		28	28	66	5	1	1
731.30.30.0		30	30	70	5	1	1
731.35.25.0		35	25	70	5	1	1
731.35.35.0		35	35	80	5	1	1

IN DOTAZIONE
N° 3 Chiavi

Art.
500-501

Included
N° 3 Keys

ARTICOLO Article	FINITURE DISPONIBILI Available Finishes	Quantità min. da ordinare
731.--.--.1	Ottone nichelato - Nickel brass	1
731.--.--.3	Ottone cromato lucido - Polish chrome brass	500
731.--.--.5	Ottone cromato satinato - Satin chrome brass	500
731.--.--.6	Ottone nichel perla - Pearl nickel brass	50
731.--.--.10	Bronzo antico - Antique bronze	500

Distanza fissa tra **A** e **B**: 10 mm
Fixed distance between **A** and **B**: 10 mm

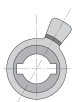



Leva DIN 30°

ARTICOLO Article	IMPIANTI SPECIALI - DESCRIZIONE Special execution - description	Sigla Abbreviation
995.00.00.0	Cifatura a chiave uguale a ns. scelta - Key alike	KA
996.00.00.0	Cifatura a chiave uguale al campione - Key alike to the sample	KAS

Cilindro in ottone per porte di servizio (WC), leva DIN 30° predisposto per pomolo.

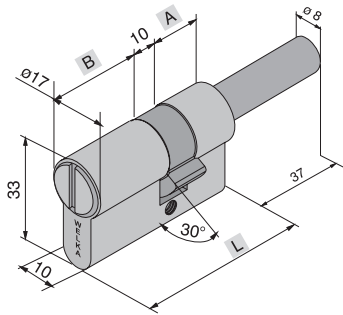
Brass cylinder for toilette, Din lever 30° pre-arranged for knob.



ARTICOLO Article	FINITURA Finish	A	B	L		Quantità min. da ordinare
735.22.22.0	Ottone - Brass	22	22	54	1	1
735.22.28.0	Ottone - Brass	22	28	60	1	1
735.22.22.1	Ottone nichelato - Nickel brass	22	22	54	1	1
735.22.28.1	Ottone nichelato - Nickel brass	22	28	60	1	1

Distanza fissa tra A e B: 10 mm
Fixed distance between A and B: 10 mm



Leva DIN 30°

Cilindro con quadro da 8 mm, per serrature da infilare per porte di servizio (WC).

Cylinder with handle hole of 8 mm, for mortice lock.

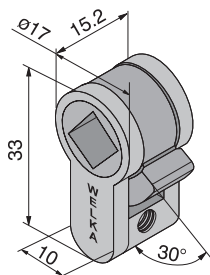

ARTICOLO Article	FINITURA Finish		Quantità min. da ordinare
740.00.00.0	Zama nichelata - Nickel zamak	10	10

PER SERRATURE

Art.
014-015-016

For locks

Pomolo tondo in zama.

Zamak round knob.

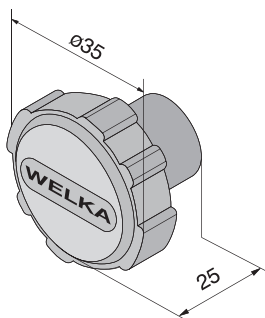

ARTICOLO Article	FINITURA Finish		Quantità min. da ordinare	
750.00.00.0	Zama ottonata - <i>Brass zamak</i>	5	5	
750.00.00.1	Zama nichelata - <i>Nickel zamak</i>	5	5	

Pomolo triangolare in ottone.

Brass triangular knob.

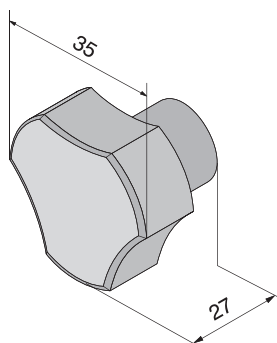

ARTICOLO Article	FINITURA Finish		Quantità min. da ordinare	
 751.00.00.0	Ottone lucido - <i>Polish brass</i>	5	5	
 751.00.00.1	Ottone nichelato - <i>Nickel brass</i>	5	5	
 751.00.00.3	Ottone cromato lucido - <i>Polish chrome brass</i>	5	5	
 751.00.00.6	Ottone nichel perla - <i>Pearl nickel brass</i>	50	50	
 751.00.00.10	Bronzo antico - <i>Antique bronze</i>	200	200	

Pomolo piatto in alluminio.

Aluminium flat knob.

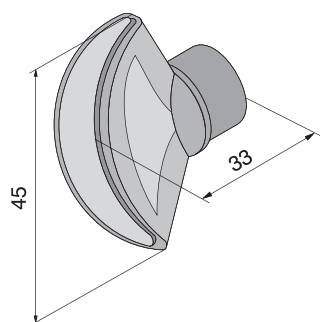



ARTICOLO Article	FINITURA Finish		Quantità min. da ordinare	
 752.00.00.0	Ottone lucido - <i>Polish brass</i>	5	5	
 752.00.00.1	Nichelato - <i>Nickeled</i>	5	5	
 752.00.00.3	Cromato lucido - <i>Polish chrome</i>	5	5	
 752.00.00.6	Nichel perla - <i>Pearl nickel</i>	50	50	
 752.00.00.10	Bronzo antico - <i>Antique bronze</i>	200	200	

Cilindro con 3 chiavi a spillo.

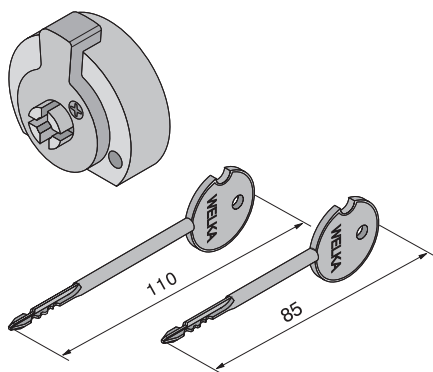
Cross key cylinder with 3 keys.



ARTICOLO Article	FINITURA Finish			Quantità min. da ordinare	
770.14.00.0	Chiave mm 85 - Key 85 mm	6	5	5	
770.15.00.0	Chiave mm 110 - Key 110 mm	6	5	5	

PER SERRATURE

Art.

For locks

083-214-247-248-255-257
258-260-262-263-268-270
274-276-280-285-287-288
311-313

ARTICOLO Article	IMPIANTI SPECIALI - DESCRIZIONE Special execution - description	Sigla Abbreviation	
995.01.00.0	Cifratura a chiave uguale a ns. scelta - Key alike	KA	
	NON SI ESEGUONO IMPIANTI, cifratura al campione - KAS NOT AVAILABLE	KAS	

Cilindro con 3 chiavi a spillo.

Cross key cylinder with 3 keys.

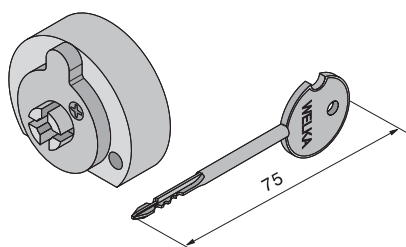

ARTICOLO Article	FINITURA Finish			Quantità min. da ordinare	
770.16.00.0	Chiave mm 75 - Key 75 mm	6	5	5	

PER SERRATURE

Art.

For locks

285-287-288
(Entrata 19 mm) - Backset mm 19

ARTICOLO Article	IMPIANTI SPECIALI - DESCRIZIONE Special execution - description	Sigla Abbreviation	
995.01.00.0	Cifratura a chiave uguale a ns. scelta - Key alike	KA	
	NON SI ESEGUONO IMPIANTI, cifratura al campione - KAS NOT AVAILABLE	KAS	