

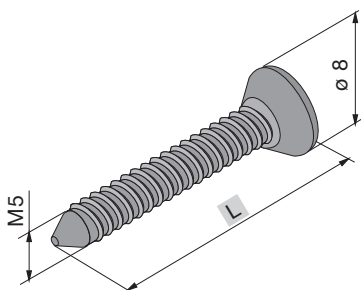

Accessori
Accessories



Viti M5 per fissaggio cilindri.

Screws M5 for fixing the cylinders.



ARTICOLO Article	FINITURA Finish	L		Quantità min. da ordinare
312.20.101	Vite in ferro ottonata - <i>Brassed steel screw</i>	32	100	20
312.20.102		39	100	20
312.20.103		44	100	20
312.20.104		49	100	20
312.20.105		59	100	20
312.20.106		69	100	20
312.20.107		79	50	20
312.20.108		89	50	20
312.20.109		109	50	20
312.20.110		23	100	20

PER CILINDRI

Art.
600-601-700-702
721-722-731-735

For cylinders

Viti M5 per fissaggio cilindri.

Screws M5 for fixing the cylinders.

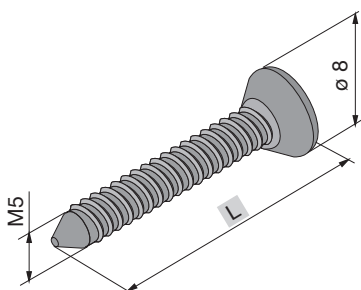

ARTICOLO Article	FINITURA Finish	L		Quantità min. da ordinare
312.20.201	Vite in ferro zincata bianca - <i>White zinked screw</i>	32	100	20
312.20.202		39	100	20
312.20.203		44	100	20
312.20.204		49	100	20
312.20.205		59	100	20
312.20.206		69	100	20
312.20.207		79	50	20
312.20.208		89	50	20
312.20.209		109	50	20
312.20.210		23	100	20

PER CILINDRI

Art.
600-601-700-702
721-722-731-735

For cylinders

Borchia per cilindri sagomati.

Rose for profile cylinders.

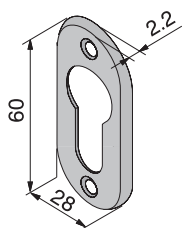

ARTICOLO Article	FINITURA Finish		Quantità min. da ordinare	
800.03.00.0	Acciaio ottonato - <i>Brass steel</i>	20	20	
800.03.01.0	Acciaio nichelato - <i>Nickel steel</i>	20	20	

PER CILINDRI

Art.
600-601-700
721-731-735

For cylinders

Borchia per cilindri sagomati predisposti per il pomolo.

Rose for profile cylinders pre-arranged for knob.

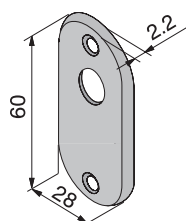

ARTICOLO Article	FINITURA Finish		Quantità min. da ordinare	
800.04.00.0	Acciaio ottonato - <i>Brass steel</i>	20	20	
800.04.01.0	Acciaio nichelato - <i>Nickel steel</i>	20	20	

PER CILINDRI

Art.
721-735

For cylinders

Borchia per cilindri ovali.

Rose for oval cylinders.

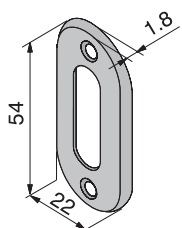

ARTICOLO Article	FINITURA Finish		Quantità min. da ordinare	
800.05.00.0	Acciaio ottonato - <i>Brass steel</i>	20	20	
800.05.01.0	Acciaio nichelato - <i>Nickel steel</i>	20	20	

PER CILINDRI

Art.
702-722

For cylinders

Borchia da saldare per cilindri sagomati.

Rose to weld for profile cylinders.

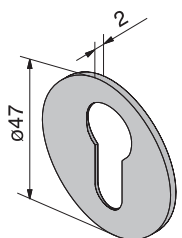

ARTICOLO Article	FINITURA Finish		Quantità min. da ordinare	
800.06.00.0	Acciaio zincato - <i>Zink steel</i>	20	20	

PER CILINDRI

Art.
600-700

For cylinders

Borchia per cilindri tondi.

Rose for round cylinders.

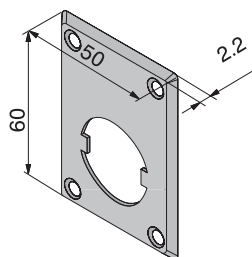

ARTICOLO Article	FINITURA Finish		Quantità min. da ordinare	
800.07.00.0	Acciaio ottonato - Brass steel	20	20	

PER CILINDRI Art. 608 For cylinders

Borchia per cilindri a croce.

Rose for cross key cylinders.

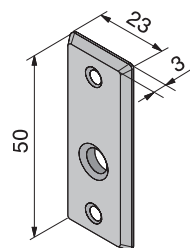

ARTICOLO Article	FINITURA Finish		Quantità min. da ordinare	
805.02.00.0	Nylon nero - Black nylon	20	20	

PER CILINDRI Art. 770 For cylinders

Borchia per cilindri tondi.

Rose for round cylinders.

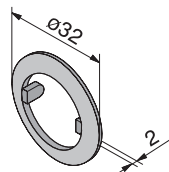

ARTICOLO Article	FINITURA Finish		Quantità min. da ordinare	
805.04.00.0	Nylon nero - Black nylon	20	20	

PER CILINDRI Art. 607 For cylinders

Borchia piana per cilindri ovali.

Flat rose for oval cylinders.

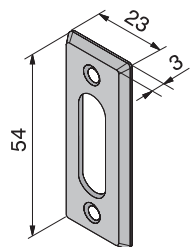

ARTICOLO Article	FINITURA Finish		Quantità min. da ordinare	
805.08.00.0	Nylon nero - Black nylon	20	20	

PER CILINDRI Art. 702-722 For cylinders

Borchia piana per cilindri sagomati.

Flat rose for profile cylinders.

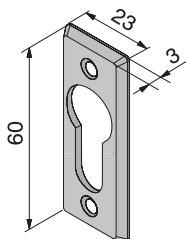

ARTICOLO Article	FINITURA Finish		Quantità min. da ordinare	
805.09.00.0	Nylon nero - Black nylon	20	20	

PER CILINDRI

Art.
600-601-700-721
731-735

For cylinders

Contropiastra con aletta.

Striking plate with tongue.

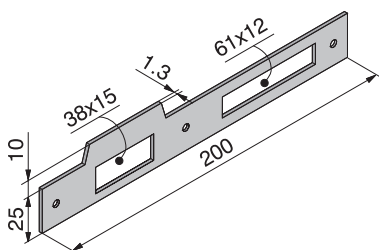

ARTICOLO Article	FINITURA Finish		Quantità min. da ordinare	
830.01.00.0	Acciaio ottonato - Brass steel	10	10	
830.01.01.0	Acciaio nichelato - Nickel steel	10	10	

PER SERRATURE

Art.
015

For LOCKS

Contropiastra Bordo tondo con aletta.

Striking plate round shape with tongue.

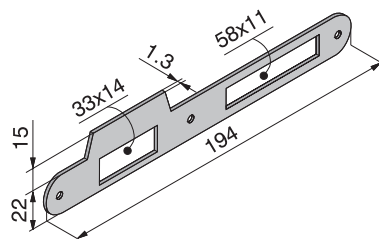

ARTICOLO Article	FINITURA Finish		Quantità min. da ordinare	
830.03.00.0	Acciaio ottonato - Brass steel	10	10	
830.03.01.0	Acciaio nichelato - Nickel steel	10	10	

PER SERRATURE

Art.
014

For locks

Contropiastra Pesante con bordo tondo.

Striking plate with round shape.

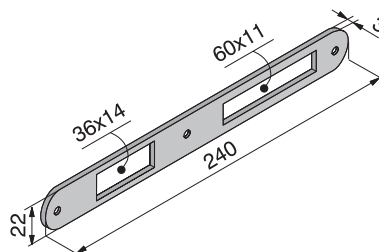

ARTICOLO Article	FINITURA Finish		Quantità min. da ordinare	
830.04.00.0	Acciaio ottonato - Brass steel	10	10	
830.04.01.0	Acciaio nichelato - Nickel steel	10	10	

PER SERRATURE

Art.
014

For locks

Contropiastra doppia aletta.

Striking plate double tongue.

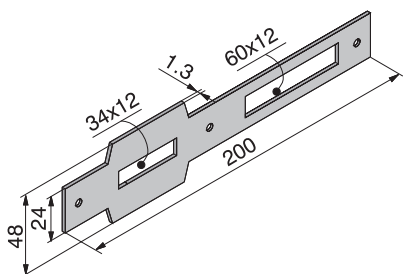

ARTICOLO Article	FINITURA Finish		Quantità min. da ordinare
830.05.00.0	Acciaio ottonato - Brass steel	10	10
830.05.01.0	Acciaio nichelato - Nickel steel	10	10

PER SERRATURE

Art.
016

For locks

Contropiastra piana.

Striking plate flat.

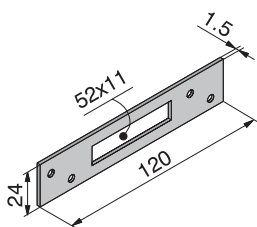

ARTICOLO Article	FINITURA Finish		Quantità min. da ordinare
830.06.00.0	Acciaio ottonato per Art. 020 - Brass steel for Art. 020	10	10
830.06.01.0	Acciaio nichelato per Art. 109 - Nickel steel for Art. 109	10	10

PER SERRATURE

Art.
020-109

For locks

Contropiastra piana.

Striking plate flat.

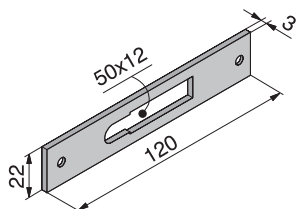

ARTICOLO Article	FINITURA Finish		Quantità min. da ordinare
830.07.00.0	Acciaio ottonato - Brass steel	10	10

PER SERRATURE

Art.
025-026

For locks

Contropiastra piana.

Striking plate flat.

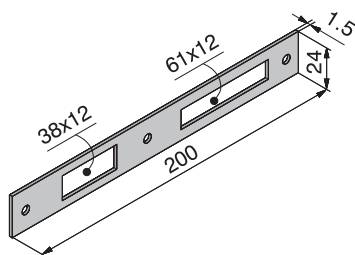

ARTICOLO Article	FINITURA Finish		Quantità min. da ordinare
830.10.01.0	Acciaio nichelato - Nickel steel	10	10
830.10.10.0	Acciaio inox - Stainless steel	10	10

PER SERRATURE

Art.
101-160AV-162AV
168-268-174-274 *con scrocco / with latch*

For locks

Contropiastra piana.

Striking plate flat.

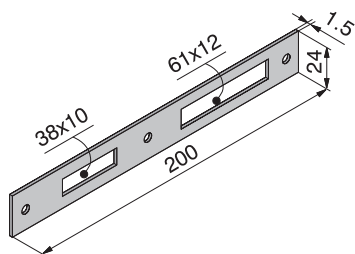

ARTICOLO Article	FINITURA Finish		Quantità min. da ordinare	
830.11.01.0	Acciaio nichelato - <i>Nickel steel</i>	10	10	
830.11.10.0	Acciaio inox - <i>Stainless steel</i>	10	10	

PER SERRATURE **Art.** **For locks**
 101-160AV-168
 268-174-274 *con rullo / with roller*

Contropiastra piana.

Striking plate flat.

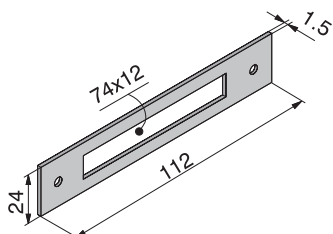

ARTICOLO Article	FINITURA Finish		Quantità min. da ordinare	
830.12.01.0	Acciaio nichelato - <i>Nickel steel</i>	10	10	
830.12.10.0	Acciaio inox - <i>Stainless steel</i>	10	10	

PER SERRATURE **Art.** **For locks**
 085-087-285-287

PER DEVIATORI MULTIPUNTO **Art.** **For multi point lock**
 170-270-176-276

Contropiastra piana con aletta.

Striking plate flat with tongue.

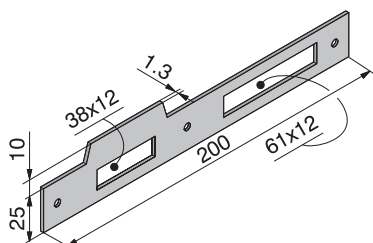

ARTICOLO Article	FINITURA Finish		Quantità min. da ordinare	
830.14.01.0	Acciaio nichelato - <i>Nickel steel</i>	10	10	
830.14.10.0	Acciaio inox - <i>Stainless steel</i>	10	10	

PER SERRATURE **Art.** **For locks**
 101 *con scrocco / with latch*

Contropiastra piana.

Striking plate flat.

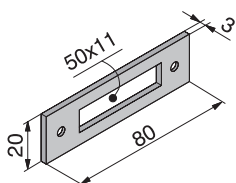



ARTICOLO Article	FINITURA Finish		Quantità min. da ordinare	
830.15.04.0	Acciaio verniciato nero - <i>Black painted steel</i>	10	10	

PER SERRATURE **Art.** **For locks**
 225-226

Contropiastra piana.

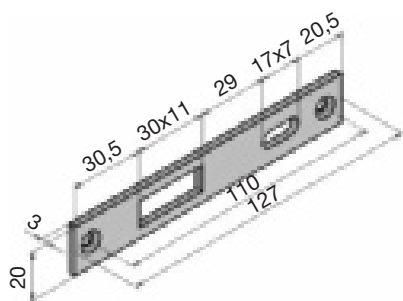
Striking plate flat.



ARTICOLO Article	FINITURA Finish		Quantità min. da ordinare
830.16.01.0	Acciaio nichelato larghezza 20 mm - <i>Nickel steel width 20 mm</i>	10	10

PER SERRATURE

Art.
106-108

For locks

Contropiastra piana.

Striking plate flat.

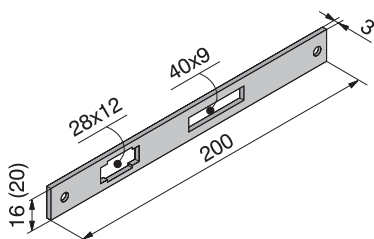

ARTICOLO Article	FINITURA Finish		Quantità min. da ordinare
830.17.01.0	Acciaio nichelato larghezza 16 mm - <i>Nickel steel width 16 mm</i>	10	10
830.17.02.0	Acciaio nichelato larghezza 20 mm - <i>Nickel steel width 20 mm</i>	10	10

PER SERRATURE

Art.
110-111

For locks

Contropiastra piana.

Striking plate flat.

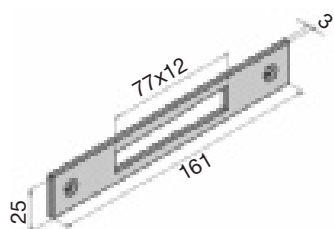

ARTICOLO Article	FINITURA Finish		Quantità min. da ordinare
830.18.10.0	Acciaio inox - <i>Stainless steel</i>	10	10

PER SERRATURE

Art.
157-257-158-258
Deviatori Multi5
Deviatori 188

For locks

Contropiastra piana.

Striking plate flat.

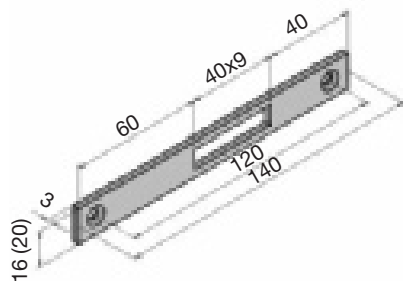

ARTICOLO Article	FINITURA Finish		Quantità min. da ordinare
830.19.01.0	Acciaio nichelato larghezza 16 mm - <i>Nickel steel width 16 mm</i>	10	10
830.19.02.0	Acciaio nichelato larghezza 20 mm - <i>Nickel steel width 20 mm</i>	10	10

PER SERRATURE

Art.
112

For locks

Contropiastra piana.

Striking plate flat.

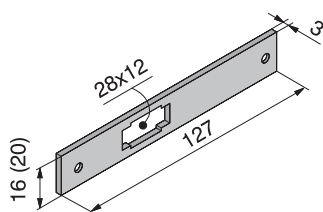

ARTICOLO Article	FINITURA Finish		Quantità min. da ordinare	
830.20.01.0	Acciaio nichelato larghezza 16 mm - Nickel steel width 16 mm	10	10	
830.20.02.0	Acciaio nichelato larghezza 20 mm - Nickel steel width 20 mm	10	10	

PER SERRATURE

Art.

113-114-115

For locks

Contropiastra piana.

Striking plate flat.

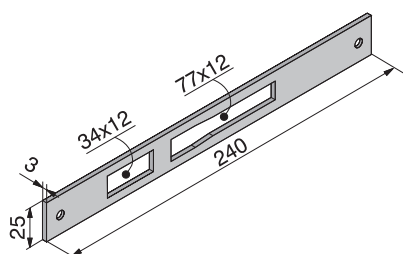

ARTICOLO Article	FINITURA Finish		Quantità min. da ordinare	
830.21.10.0	Acciaio inox - Stainless steel	10	10	

PER SERRATURE

Art.

155-160-160AV

255-260-310

Multi5

For locks

Contropiastra piana bordo tondo.

Striking plate flat round plate.

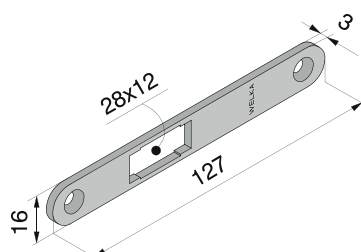

ARTICOLO Article	FINITURA Finish		Quantità min. da ordinare	
830.22.01.0	Acciaio nichelato larghezza 16mm - Nickel steel width 16mm	10	10	
830.22.30.0	Acc. crom. satin. larg. 16mm - Satin chrome steel width 16mm	10	10	

PER SERRATURE

Art.

1141

For locks

NOVITA'
NEW

Contropiastra.

Striking plate.

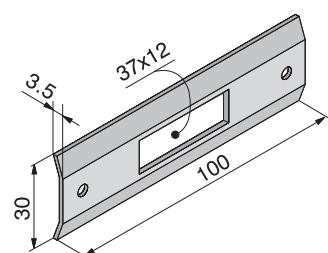

ARTICOLO Article	FINITURA Finish		Quantità min. da ordinare	
835.01.01.0	Acciaio zincato - Zinc steel	10	10	

PER SERRATURE

Art.

121-122-123

For locks

Sottofrontale h 5 mm per serrature da montante e da fascia.

Under forendplate h 5 mm for vertical and horizontal locks.

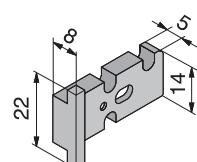

ARTICOLO Article	FINITURA Finish		Quantità min. da ordinare	
850.07.00.0	Nylon nero - Black nylon	10	10	

Contropiastre regolabili acciaio inox per profili a Camera Europea.

Stainless steel adjustable striking plate for Euro Groove profiles.

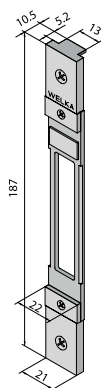

ARTICOLO Article	FINITURA Finish		Quantità min. da ordinare
860.01.10.0	Acciaio inox - Stainless steel	10	10

PER SERRATURE
DA FASCIA E DEVIATORI

For locks
For horizontal profiles and extra bolts.

Compatibile con tutte le serrature Welka da fascia e deviatori.

Compatible with all Welka locks for horizontal profiles and extra bolts.

Regolazione Verticale tramite piastrine filettate e in orizzontale +/- 7 mm

Regulation with threaded platelets and in horizontal +/- 7 mm

* COMPATIBILITÀ CONTROPIASTRE

* COMPATIBILITY CHART

Contropiastre regolabili acciaio inox per profili a Camera Europea.

Stainless steel adjustable striking plate for Euro Groove profiles.

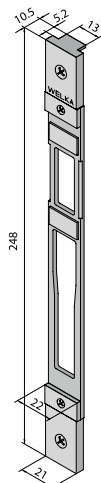

ARTICOLO Article	FINITURA Finish		Quantità min. da ordinare
860.02.10.0	Acciaio inox - Stainless steel	10	10

PER SERRATURE
DA MONTANTE

For locks
For vertical locks

Compatibile con tutte le serrature Welka da fascia e deviatori.

Compatible with all Welka locks for horizontal profiles and extra bolts.

Regolazione Verticale tramite piastrine filettate e in orizzontale +/- 7 mm

Regulation with threaded platelets and in horizontal +/- 7 mm

* COMPATIBILITÀ CONTROPIASTRE

* COMPATIBILITY CHART

* COMPATIBILITÀ CONTROPIASTRE ART. 860.01.10.0 e 860.02.10.0

COMPATIBILITY CHART ART. 860.01.10.0 and 860.02.10.0.

PRODUTTORE Manufacturer	NOME PROFILO Profile name
ALCAN	Abithal Cristal / Abithal Keeper Porta C.E. / Winner Finestra
ALCOA	Fb 12 Ga / Europa Ga / Fb 12 T.T. / R 35 Reversibile/R 35 Sormonto
ALL.CO	Export 40 Finestra / Export 45 Tt Finestra / Export 50 Finestra / Export 50 Tt Finestra / Final 40 Finestra / Sicurblin C.E.
ALU-MEC	Synthesis 45 Finestra / Synthesis 57 Finestra / Synthesis 60 Tt Finestra
ALUSUISSE	Alsec 2000 Finestra 59 / Alsec 2000 Finestra 69
BODEGA	Bga 50 / New Bt 60
DOMAL	Domal Break 52 Finestra / Domal Break 70 Finestra / Domal Stopper Pg Finestra
EQUIPE	Sistema 8000 G.A. Finestra 1 Anta / Sistema 8000 G.A. Finestra 2 Ante / Sistema 8000 Tt Finestra 1 Anta / Sistema 8000 Tt Finestra 2 Ante
ESA	Isola Porta
ESEDRA	Ga 53 Porta / Tt 63 Porta / Tt 75 Porta
INDINVEST	Gold 400 Complanare / Gold 400 Sormonto / Gold 500 Complanare / Gold 500 Sormonto / Gold 600 Complanare / Gold 600 Sormonto
METRA	Nc 45 International Finestra / Nc 45 Superthermic Finestra / Nc 55 International Finestra / Nc 68 Superthermic Finestra / Nuovo Nc 40 Sorm. 2 Ante Con Riporto / Nuovo Nc 40 Sormonto 1 Anta
MORELLI	Ma 8300
OCMA	Fc 47 Finestra / Fc 55 Finestra / Fc 60 Tt Finestra
PASSERINI	Ekip 40 Evoluzione 1 Anta / Ekip 40 Evoluzione 2 Ante / Ekip 40 Sormonto 1 Anta / Ekip 40 Sormonto 2 Ante / Ekip Maastricht 53 Finestra / Ekip Maastricht Th 60 Finestra / Ekip Maastricht Th 68 Finestra
PROFILATI	"Pe ""Eku 53"" Finestra" / "Pe ""Eku 64 Tt"" Finestra" / "Pe ""Eku 72 Tt"" Finestra" / Sistema 1 Pe 40 Comp./Est. 1 Anta / Sistema 1 Pe 40 Sormonto 1 Anta / Sistema 1 Pe 50 Comp./Est. 1 Anta / Sistema 1 Pe 50 Sormonto 1 Anta

Contropiastre regolabili acciaio inox per profili R40 - R50.

Stainless steel adjustable striking plate for R40 - R50 profiles.

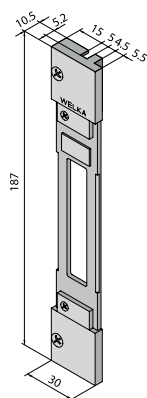

ARTICOLO Article	FINITURA Finish		Quantità min. da ordinare
860.03.10.0	Acciaio inox - <i>Stainless steel</i>	10	10

PER SERRATURE
DA FASCIA E DEVIATORI

For locks
For horizontal profiles and extra bolts.

Compatibile con tutte le serrature Welka da fascia e deviatori.

Compatible with all Welka locks for horizontal profiles and extra bolts.

Regolazione Verticale tramite piastrine filettate e in orizzontale +/- 7 mm

Regulation with threaded platelets and in horizontal +/- 7 mm

** COMPATIBILITÀ CONTROPIASTRE

** COMPATIBILITY CHART

Contropiastre regolabili acciaio inox per profili R40 - R50.

Stainless steel adjustable striking plate for R40 - R50 profiles.

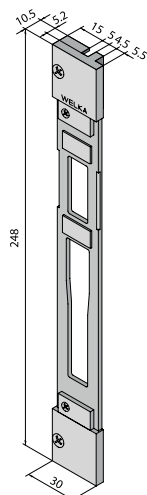

ARTICOLO Article	FINITURA Finish		Quantità min. da ordinare
860.04.10.0	Acciaio inox - <i>Stainless steel</i>	10	10

PER SERRATURE
DA MONTANTE

For locks
For vertical locks

Compatibile con tutte le serrature Welka da fascia e deviatori.

Compatible with all Welka locks for horizontal profiles and extra bolts.

Regolazione Verticale tramite piastrine filettate e in orizzontale +/- 7 mm

Regulation with threaded platelets and in horizontal +/- 7 mm

** COMPATIBILITÀ CONTROPIASTRE

** COMPATIBILITY CHART

** COMPATIBILITÀ CONTROPIASTRE ART. 860.03.10.0 e 860.04.10.0 | COMPATIBILITY CHART ART. 860.03.10.0 and 860.04.10.0

PRODUTTORE Manufacturer	NOME PROFILO Profile name
ALCOA	Alublind / R 40 Reversibile 1 Anta / R 40 Reversibile 2 Ante R 40 Sormonto 1 Anta / R 40 Sormonto 2 Ante R 50 Sormonto 1 Anta / R 50 Sormonto 2 Ante R 50 Tt Sormonto 1 Anta / R 50 Tt Sormonto 2 Ante

Contropiastra.

Striking plate.

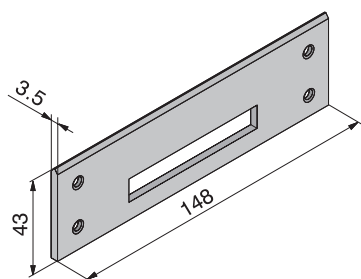

ARTICOLO Article	FINITURA Finish		Quantità min. da ordinare	
865.03.00.0	Nylon nero - Black nylon	10	10	

PER SERRATURE **Art.** **For locks**
130-133-136

PER PROFILI Serie DOMAL Gelosia **For profile**

Contropiastra.

Striking plate.

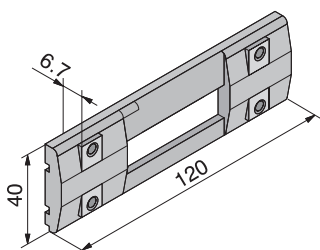

ARTICOLO Article	FINITURA Finish		Quantità min. da ordinare	
865.20.00.0	Nylon nero - Black nylon	10	10	

PER SERRATURE **Art.** **For locks**
130-133-136

Contropiastra.

Striking plate.

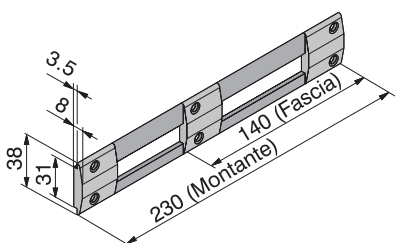

ARTICOLO Article	FINITURA Finish		Quantità min. da ordinare	
870.01.00.0	Nylon nero - Black nylon	10	10	

PER SERRATURE **Art.** **For locks**
DA MONTANTE 101 For vertical locks
DA FASCIA Serie 127-130-133-136-147 For horizontal locks
ELETTRICHE 304-306-320-322-324-326 For electric locks

Contropiastra.

Striking plate.

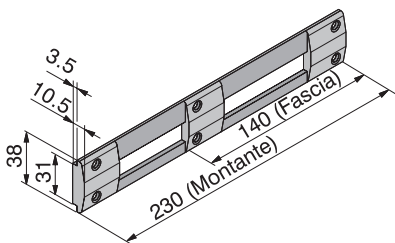

ARTICOLO Article	FINITURA Finish		Quantità min. da ordinare	
870.02.00.0	Nylon nero - Black nylon	10	10	

PER SERRATURE **Art.** **For locks**
DA MONTANTE 101 For vertical locks
DA FASCIA Serie 127-130-133-136-147 For horizontal locks
ELETTRICHE 304-306-320-322-324-326 For electric locks

Contropiastra.

Striking plate.

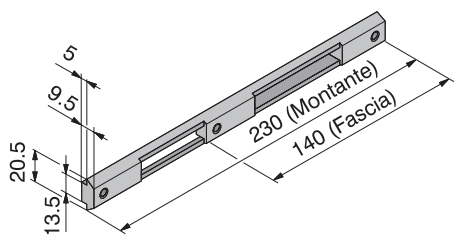

ARTICOLO Article	FINITURA Finish		Quantità min. da ordinare
870.06.00.0	Nylon nero - Black nylon	10	10

PER SERRATURE	Art.	Art.
DA MONTANTE	101	101
DA FASCIA	Serie 127-130-133-136-147	Serie 127-130-133-136-147
ELETTRICHE	304-306-320-322-324-326	304-306-320-322-324-326

Contropiastra.

Striking plate.

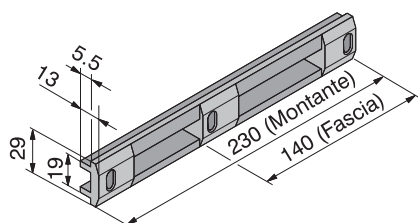

ARTICOLO Article	FINITURA Finish		Quantità min. da ordinare
870.10.00.0	Nylon nero - Black nylon	10	10

PER SERRATURE	Art.	Art.
DA MONTANTE	101	101
DA FASCIA	Serie 127-130-133-136-147	Serie 127-130-133-136-147
ELETTRICHE	304-306-320-322-324-326	304-306-320-322-324-326

Contropiastra con spessore.

Striking plate with thickness.

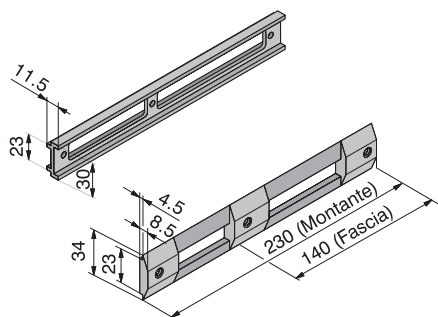

ARTICOLO Article	FINITURA Finish		Quantità min. da ordinare
870.18.00.0	Nylon nero - Black nylon	10	10

PER SERRATURE	Art.	For locks
DA MONTANTE	101	For vertical locks
DA FASCIA	Serie 127-130-133-136-147	For horizontal locks
ELETTRICHE	304-306-320-322-324-326	For electric locks
	Per profili Doral 40	

Contropiastra senza spessore.

Striking plate without thickness.

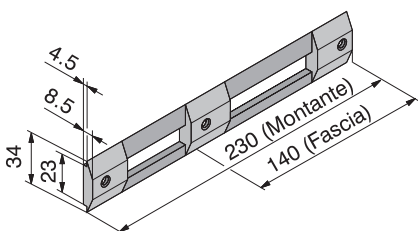



ARTICOLO Article	FINITURA Finish		Quantità min. da ordinare
870.18.00.0 SS	Nylon nero - Black nylon	10	10

PER SERRATURE	Art.	For locks
DA MONTANTE	101	For vertical locks
DA FASCIA	Serie 127-130-133-136-147	For horizontal locks
ELETTRICHE	304-306-320-322-324-326	For electric locks
	Per profili Doral 40	

Contropiastra.

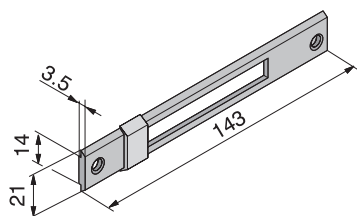
Striking plate.



ARTICOLO Article	FINITURA Finish		Quantità min. da ordinare
875.02.15.0	Alluminio nero - Black aluminium	10	10

PER SERRATURE
DA FASCIA
ELETTRICHE

Art.
Serie 127-130-133-136-147-247
304-306-320-322-324-326

For locks
For horizontal locks
For electric locks

Contropiastra.

Striking plate.

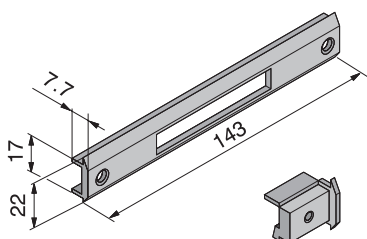

ARTICOLO Article	FINITURA Finish		Quantità min. da ordinare
875.09.15.0	Alluminio nero - Black aluminium	10	10

PER SERRATURE
DA FASCIA
ELETTRICHE

Art.
Serie 127-130-133-136-147-247
304-306-320-322-324-326

For locks
For horizontal locks
For electric locks

Contropiastra.

Striking plate.

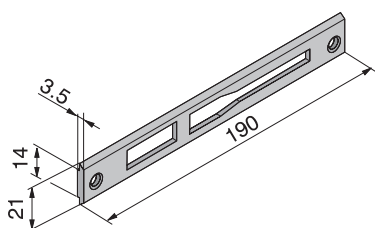

ARTICOLO Article	FINITURA Finish		Quantità min. da ordinare
875.17.15.0	Alluminio nero - Black aluminium	10	10

PER SERRATURE
DA MONTANTE
ELETTRICHE

Art.
101 Serie 155-160-255-260
310-312

For locks
For vertical locks
For electric locks

Contropiastra.

Striking plate.

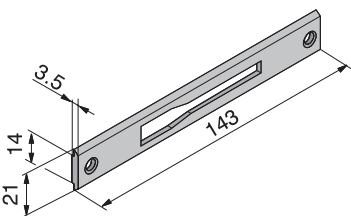

ARTICOLO Article	FINITURA Finish		Quantità min. da ordinare
875.18.15.0	Alluminio nero - Black aluminium	10	10

PER DEVIATORI

Art.
188

For locks
For deadbolts

Contropiastra.

Striking plate.

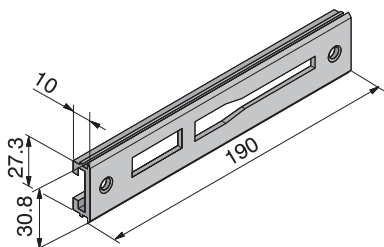

ARTICOLO Article	FINITURA Finish		Quantità min. da ordinare	
875.19.15.0	Alluminio nero - <i>Black aluminium</i>	10	10	

**PER SERRATURE
DA MONTANTE
ELETTRICHE**

Art.
101 Serie 155-160-255-260
310-312

For locks
For vertical locks
For electric locks

Contropiastra.

Striking plate.

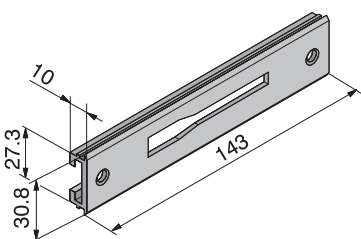

ARTICOLO Article	FINITURA Finish		Quantità min. da ordinare	
875.20.15.0	Alluminio nero - <i>Black aluminium</i>	10	10	

PER DEVIATORI

Art.
188

For deadbolts

Contropiastra.

Striking plate.

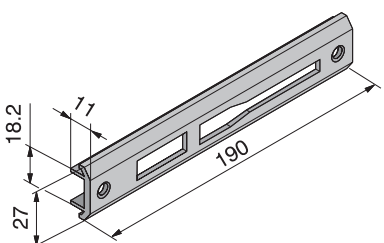

ARTICOLO Article	FINITURA Finish		Quantità min. da ordinare	
875.23.15.0	Alluminio nero - <i>Black aluminium</i>	10	10	

**PER SERRATURE
DA MONTANTE
ELETTRICHE**

Art.
101 Serie 155-160-255-260
310-312

For locks
For vertical locks
For electric locks

Contropiastra.

Striking plate.

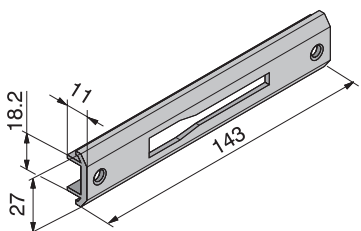

ARTICOLO Article	FINITURA Finish		Quantità min. da ordinare	
875.24.15.0	Alluminio nero - <i>Black aluminium</i>	10	10	

PER DEVIATORI

Art.
188

For deadbolts

Contropiastra.

Striking plate.

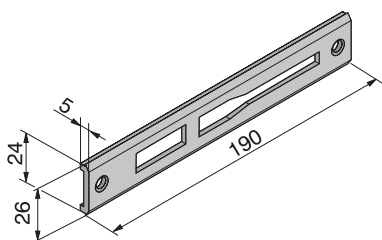

ARTICOLO Article	FINITURA Finish		Quantità min. da ordinare
875.27.15.0	Alluminio nero - Black aluminium	10	10

**PER SERRATURE
DA MONTANTE
ELETTRICHE**

Art.
101 Serie 155-160-255-260
310-312

For locks
For vertical locks
For electric locks

Contropiastra.

Striking plate.

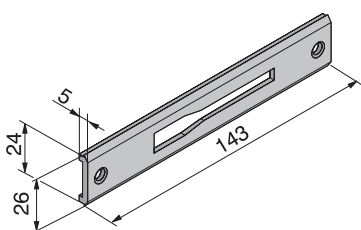

ARTICOLO Article	FINITURA Finish		Quantità min. da ordinare
875.28.15.0	Alluminio nero - Black aluminium	10	10

PER DEVIATORI

Art.
188

For deadbolts

Contropiastra.

Striking plate.

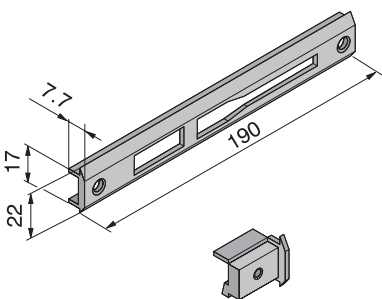

ARTICOLO Article	FINITURA Finish		Quantità min. da ordinare
875.33.15.0	Alluminio nero - Black aluminium	10	10

**PER SERRATURE
DA MONTANTE
ELETTRICHE**

Art.
101 Serie 155-160-255-260
310-312

For locks
For vertical locks
For electric locks

Contropiastra.

Striking plate.

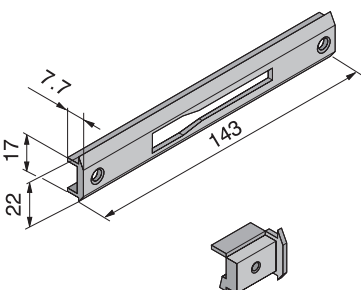

ARTICOLO Article	FINITURA Finish		Quantità min. da ordinare
875.34.15.0	Alluminio nero - Black aluminium	10	10

PER DEVIATORI

Art.
188

For deadbolts

Contropiastra.

Striking plate.

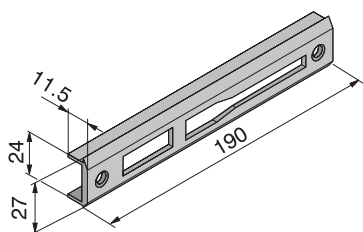

ARTICOLO Article	FINITURA Finish		Quantità min. da ordinare
875.39.15.0	Alluminio nero - <i>Black aluminium</i>	10	10

**PER SERRATURE
DA MONTANTE
ELETTRICHE**

Art.
101 Serie 155-160-255-260
310-312

For locks
For vertical locks
For electric locks

Contropiastra.

Striking plate.

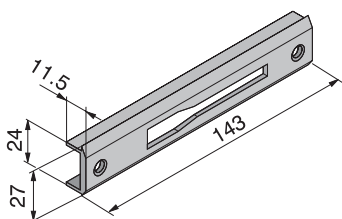

ARTICOLO Article	FINITURA Finish		Quantità min. da ordinare
875.40.15.0	Alluminio nero - <i>Black aluminium</i>	10	10

PER DEVIATORI

Art.
188

For deadbolts

Riporto in nylon nero per contropiastre.

Black nylon spacer for striking plates.

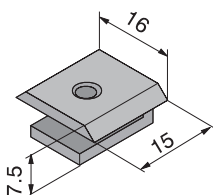

ARTICOLO Article	FINITURA Finish		Quantità min. da ordinare
875.98.00.0	Alluminio nero - <i>Black aluminium</i>	10	10

PER INCONTRI

Art.
Serie 875

For striking plates

**PER SERRATURE
ELETTRICHE**

Art.
304-306-310-311-312
313-320-322-324-326

For electric locks

Contropiastra.

Striking plate.

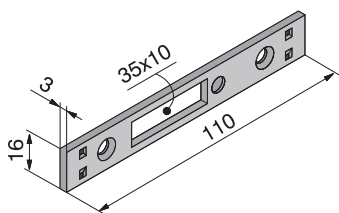

ARTICOLO Article	FINITURA Finish		Quantità min. da ordinare	
876.01.15.0	Acciaio verniciato nero - <i>Black painted steel</i>	10	10	

PER SERRATURE

Art.
205-206-207

For locks

Contropiastra.

Striking plate.

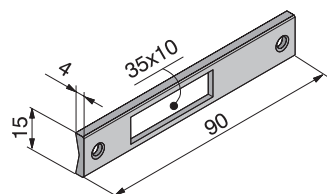

ARTICOLO Article	FINITURA Finish		Quantità min. da ordinare	
876.02.15.0	Alluminio ox. nero - <i>Black aluminium</i>	10	10	

PER SERRATURE

Art.
205-206-207

For locks

Contropiastra.

Striking plate.

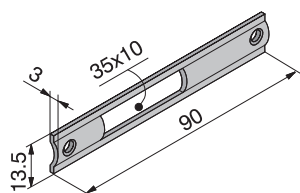

ARTICOLO Article	FINITURA Finish		Quantità min. da ordinare	
876.03.04.0	Acciaio verniciato nero - <i>Black painted steel</i>	10	10	

PER SERRATURE

Art.
205-206-207

For locks

Contropiastra.

Striking plate.

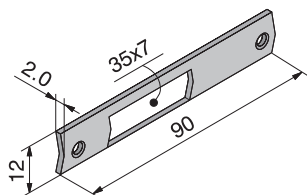

ARTICOLO Article	FINITURA Finish		Quantità min. da ordinare	
876.04.04.0	Acciaio verniciato nero - <i>Black painted steel</i>	10	10	

PER SERRATURE

Art.
201-202-203

For locks

Scrocco regolabile e intercambiabile.

Adjustable and changeable latch.

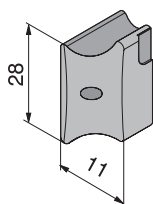

ARTICOLO Article	FINITURA Finish		Quantità min. da ordinare	
885.00.00.1	Zama nichelata - <i>Nickelated zamak</i>	10	10	

PER SERRATURE

Art.
101-155-160-168-174-213
214-255-260-268-274

For locks

Rullo regolabile e intercambiabile.

Adjustable and changeable roller.

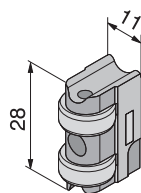

ARTICOLO Article	FINITURA Finish		Quantità min. da ordinare	
886.00.00.1	Zama nichelata - <i>Nickelated zamak</i>	10	10	

PER SERRATURE

Art.
101-155-160-168-174
255-260-268-274

For locks